



US00D863721S

(12) **United States Design Patent**
Campos

(10) **Patent No.:** **US D863,721 S**

(45) **Date of Patent:** **** Oct. 22, 2019**

(54) **BRASSIERE**

(71) Applicant: **Victoria’s Secret Stores Brand Management, Inc.**, Reynoldsburg, OH (US)

(72) Inventor: **Antonio Campos**, New York, NY (US)

(73) Assignee: **Victoria’s Secret Stores Brand Management, Inc.**, Reynoldsburg, OH (US)

(**) Term: **15 Years**

(21) Appl. No.: **29/645,657**

(22) Filed: **Apr. 27, 2018**

(51) **LOC (12) Cl.** **02-01**

(52) **U.S. Cl.**
USPC **D2/706**

(58) **Field of Classification Search**
USPC **D2/706–709, 723**

(Continued)

(56) **References Cited**

U.S. PATENT DOCUMENTS

D45,287 S 2/1914 Burns et al.
2,390,142 A 12/1945 Witkower

(Continued)

FOREIGN PATENT DOCUMENTS

EM 001352546-0007 6/2013
EM 001352546-0008 6/2013
EM 003091024-0001 1/2017

OTHER PUBLICATIONS

Aiyihan, “Women’s Crossback Yoga Sports Bra Crop Tops Comfort Bralette”, <https://www.amazon.com/AIYIHAN-Womens-Crossback-Comfort-Bralette/dp/B01IGGQ058>, available at least as early as Sep. 18, 2017.

(Continued)

Primary Examiner — Catherine R Oliver-Garcia

Assistant Examiner — J. Thorn, Sr.

(74) *Attorney, Agent, or Firm* — Andrus Intellectual Property Law, LLP

(57) **CLAIM**

The ornamental design for a brassiere, as shown and described.

DESCRIPTION

FIG. 1 is a front left side perspective view of a first embodiment of a brassiere according to my new and ornamental design, wherein a portion of the side of the brassiere is removed to expose the inner face of the rear of the brassiere;

FIG. 2 is a rear right side perspective view thereof;

FIG. 3 is a front elevation view thereof;

FIG. 4 is a rear elevation view thereof;

FIG. 5 is a left side elevation view thereof;

FIG. 6 is a right side elevation view thereof;

FIG. 7 is a top plan view thereof;

FIG. 8 is a bottom plan view thereof;

FIG. 9 is a perspective view of the brassiere of FIG. 1 shown in an alternate position;

FIG. 10 is a front elevation view thereof shown in the alternate position;

FIG. 11 is a rear elevation view thereof shown in the alternate position;

FIG. 12 is a rear right side perspective view of a second embodiment of a brassiere according to my new and ornamental design, wherein the inner face of the rear of the second embodiment of the brassiere is identical to that shown in FIG. 1;

FIG. 13 is a front left side perspective view of a third embodiment of a brassiere according to my new and ornamental design, wherein a portion of the left side of the brassiere is removed to expose the inner face of the rear of the brassiere;

FIG. 14 is a rear right side perspective view thereof.

FIG. 15 is a front elevation view thereof;

FIG. 16 is a rear elevation view thereof;

FIG. 17 is a left side elevation view thereof;

FIG. 18 is a right side elevation view thereof;

(Continued)

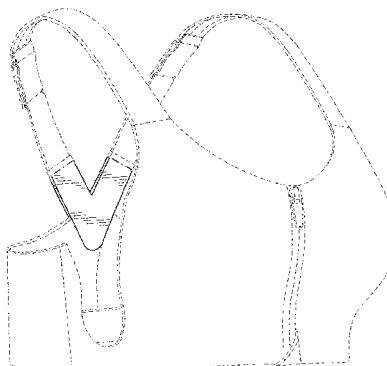

FIG. 19 is a top plan view thereof;
 FIG. 20 is a bottom plan view thereof;
 FIG. 21 is a perspective view of the brassiere of FIG. 13 shown in an alternate position;
 FIG. 22 is a front elevation view thereof shown in the alternate position;
 FIG. 23 is a rear elevation view thereof shown in the alternate position; and,
 FIG. 24 is a rear right side perspective view of a fourth embodiment of a brassiere according to my new and ornamental design, wherein the inner face of the rear of the fourth embodiment of the brassiere is identical to that shown in FIG. 13.

The broken lines in FIGS. 1-24 illustrate portions of the brassiere that form no part of the claimed design. The dash-dot-dash lines between the solid line portions and the broken line portions of the brassiere show the boundaries of the claimed design and form no part of the claim.

1 Claim, 24 Drawing Sheets

(58) **Field of Classification Search**
 CPC A41C 1/06; A41C 3/00; A41C 3/02
 See application file for complete search history.

(56) **References Cited**

U.S. PATENT DOCUMENTS

2,609,540	A	9/1952	Lo Cascio	
4,538,614	A	9/1985	Henderson	
4,718,878	A	1/1988	Tullio	
4,816,005	A	3/1989	Braaten	
D403,486	S	1/1999	Chetwynd	
5,946,726	A	9/1999	Green	
6,165,045	A	12/2000	Miller et al.	
6,168,498	B1	1/2001	Wagner	
6,186,861	B1	2/2001	Flaherty	
D438,691	S	3/2001	Zagame	
7,090,558	B2	8/2006	Ott	
7,588,479	B2	9/2009	Falla	
D635,329	S	4/2011	Wahl et al.	
7,922,682	B2	4/2011	Bell et al.	
D641,133	S	7/2011	Zarabi	
D671,296	S *	11/2012	Iamartino	D2/708
8,523,629	B2	9/2013	Pundyk	
D690,905	S	10/2013	Eutsey et al.	
8,832,862	B1	9/2014	Solis	
D724,817	S	3/2015	Randall	
D744,718	S	12/2015	Randall	
D764,747	S *	8/2016	Castaneda Smids	D2/708
9,578,901	B2	2/2017	Randall et al.	
D808,114	S *	1/2018	Begrliche	D2/731
D831,303	S *	10/2018	Rendone	D2/708
D835,882	S *	12/2018	Robertson	D2/706
D843,685	S *	3/2019	Rendone	D2/706
2011/0067162	A1	3/2011	Solis	
2011/0104985	A1	5/2011	Linder et al.	
2012/0021669	A1	1/2012	Johnstone	
2012/0045967	A1	2/2012	Punsal	
2015/0223525	A1 *	8/2015	Miller	A41C 3/0057 450/65
2015/0264982	A1	9/2015	Randall et al.	
2019/0110524	A1 *	4/2019	Kelley	A41F 15/00

OTHER PUBLICATIONS

Victoria's Secret, Brassiere, photograph of brassiere, date unknown.
 XXIV Active, Brassiere, photograph of brassiere, date unknown.
 Anita, "Active Front Close Sports Bra", <http://www.herroom.com/anita-5523-active-front-close-sports-bra.shtml>, web site visited on May 9, 2014.
 Body Central, "Zip Front Sports Bra", <http://www.bodycentral.com/products/zip-front-sports-bra/>, web site visited on May 9, 2014.
 Fruit of the Loom, "Front Close Racerback Sport Bra", <http://www.walmart.com/ip/Fruit-of-the-Loom-Front-Close-Racerback-Sport-Bra-2-pack-FT390/33102925>, web site visited on May 20, 2014.
 Playtex, "Play Zip Zip Hurray Front-Close Wirefree Bra", http://www.championusa.com/workout-clothes/women/sports-bras/everyday-bras-85068-1/playtex-play-zip-zip-hurray-wirefree-bra-25658?cm_vc=OnsiteSearch&csSearchTerm=playtex+play+zip+zip, web site visited on May 9, 2014.
 CW-X, "XTEMPO Running Bra", <http://cw-x.com/ExploreProducts.aspx?product=bras&by=collection&gender=womens>, web site visited on May 9, 2014 and Dec. 15, 2014.
 Danskin, "Danskin Now—Front Close Deep Plunge Sport Bra", <http://www.walmart.com/ip/Danskin-Now-Front-Close-Deep-Plunge-Sport-Bra/17480246>, web site visited on May 20, 2014.
 Fruit of the Loom, "Comfort Front-Close Sports Bra", <http://www.walmart.com/ip/Fruit-of-the-Loom-Comfort-Front-Close-Sports-Bra-Style-96014/13997192>, web site visited on May 20, 2014.
 Enell, "Sports Bra 100", <http://www.herroom.com/enell-100-sports-bra.shtml>, web site visited on May 20, 2014.
 Enell, "Lite Sports Bra NL101", http://www.herroom.com/Enell-NL101-Lite-Sports-Bra.shtml?utm_source=adv&utm_medium=search&device=c&network=g&matchtype=&utm_campaign=pla, web site visited on May 20, 2014.
 Champion, "The Zip Sports Bra", <http://www.hanes.com/champion/womens-workout/sports-bras/shop-all-bras/champion-the-zip-sports-bra-cb7920>, web site visited on Dec. 15, 2014.
 Lululemon Athletica, "Lift & Separate IV", <http://shop.lululemon.com/products/clothes-accessories/bras-medium-support/Lift-And-Separate-IV?cc=7501&skuId=3533091&catId=bras-medium-support>, web site visited on May 20, 2014.
 Nike, "Women's Pro Bra Zip Front", http://www.tennisexpress.com/NIKE-Womens-Pro-Bra-Zip-Front-32275?utm_source=google&utm_medium=cse&utm_term=k=&gclid=CMSQ8qiQu74CFXQiMgodhCsAQQ, web site visited on May 20, 2014.
 Playtex, "Women's Play Zip Zip Hurray Wirefree Racerback Bra", <http://www.amazon.com/Playtex-Womens-Hurray-Wirefree-Racerback/dp/B00FXT66ME>, web site visited on May 20, 2014.
 Shock Absorber, "Active Zipped Plunge", <http://shockabsorber.co.uk/en/products/active-range/active-zipped-plunge/>, web site visited on May 20, 2014.
 Spanx, "Top-Notch Sports Bra", http://www.spanx.com/shop/spanx/active/style/sports-bras/top-notch-sports-bra-zid38-1942/cat-38-catid-fncat_spx_act_styl_br_sprt, web site visited on May 20, 2014.
 Under Armour, "Armour Bra Protegee D Cup", <http://www.underarmour.com/shop/us/en/armour-bra-protege-d-cup/pid1236592>, web site visited on May 20, 2014.
 Valmont, "Zip Front Sports Bra", <http://www.hanes.com/justmysize/active/plus-styles/plussize-sports-bra/valmont-zip-front-sports-bra-20357>, web site visited on May 20, 2014.

* cited by examiner

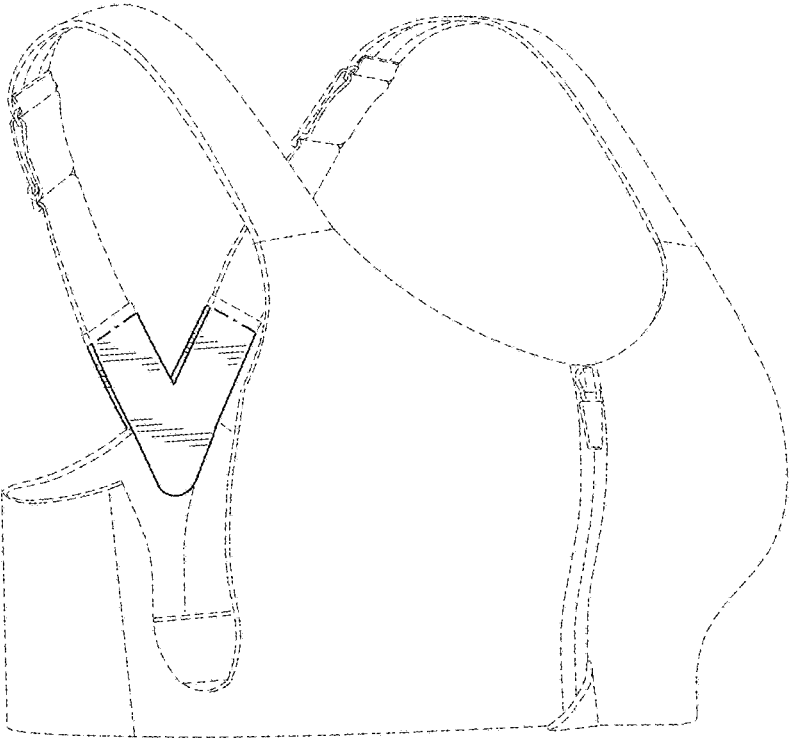

FIG. 1

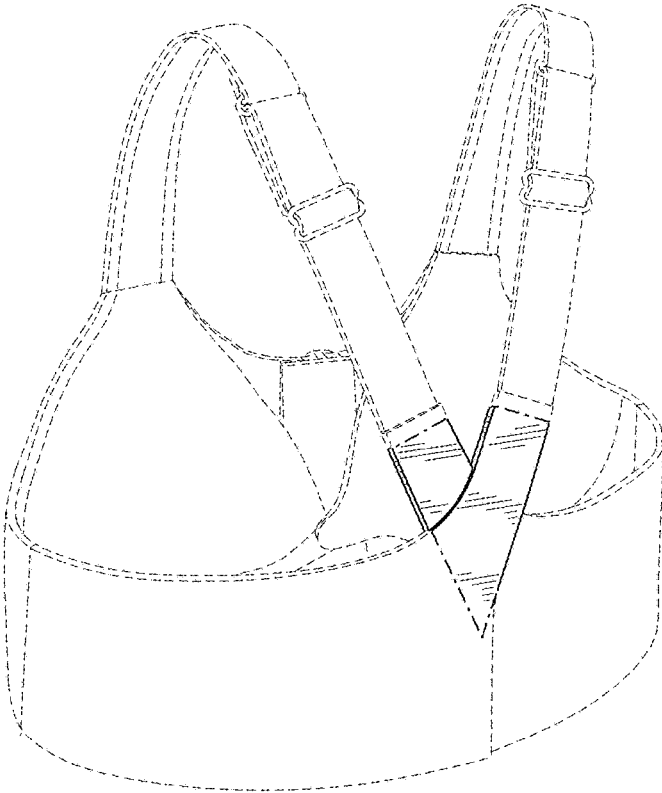

FIG. 2

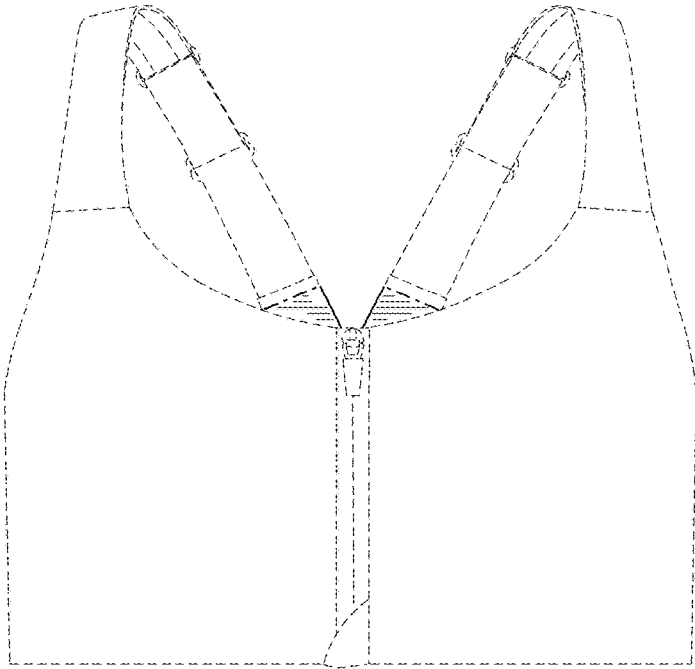

FIG. 3

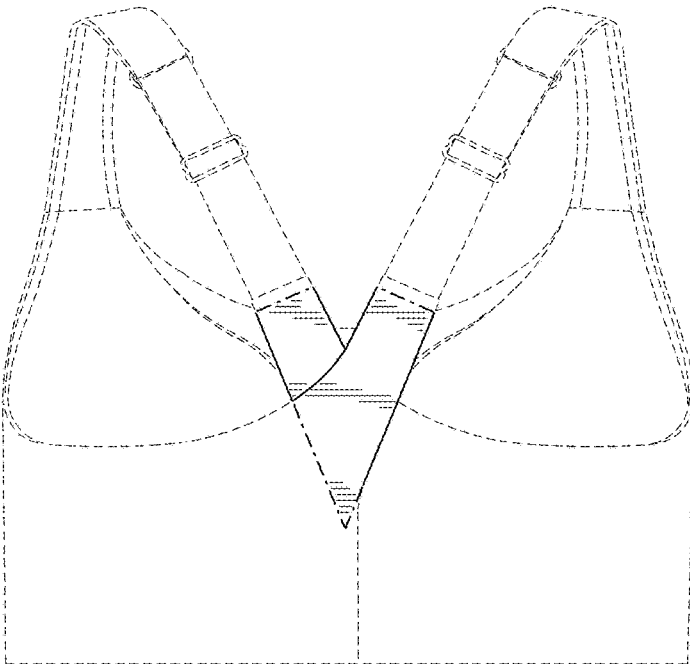

FIG. 4



FIG. 5

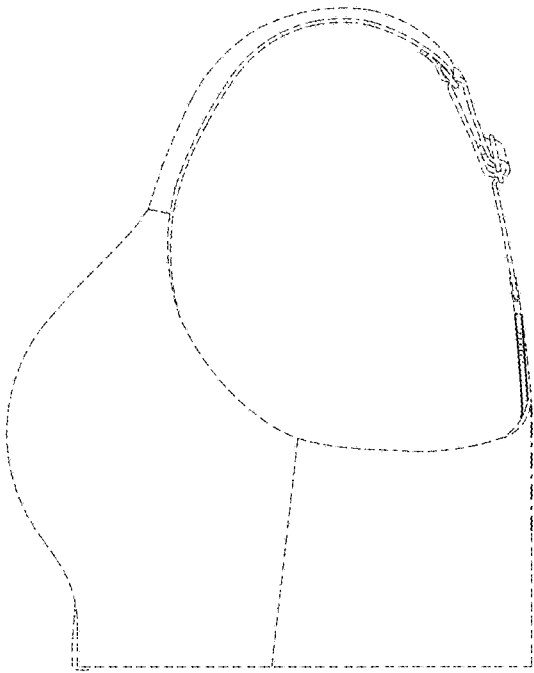

FIG. 6

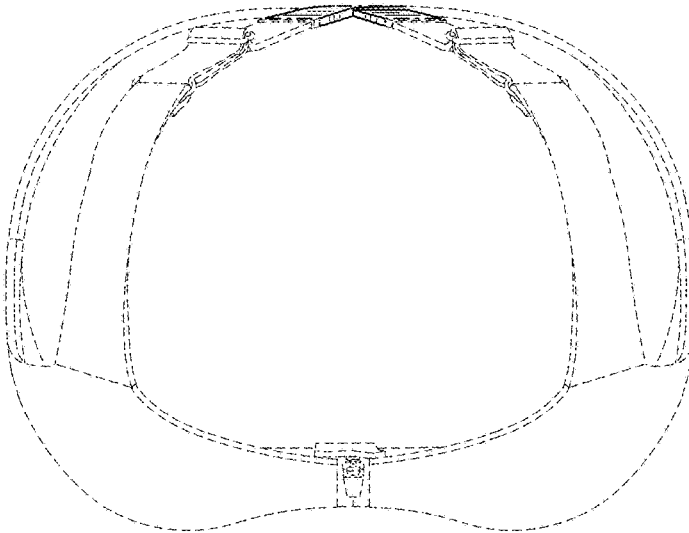

FIG. 7

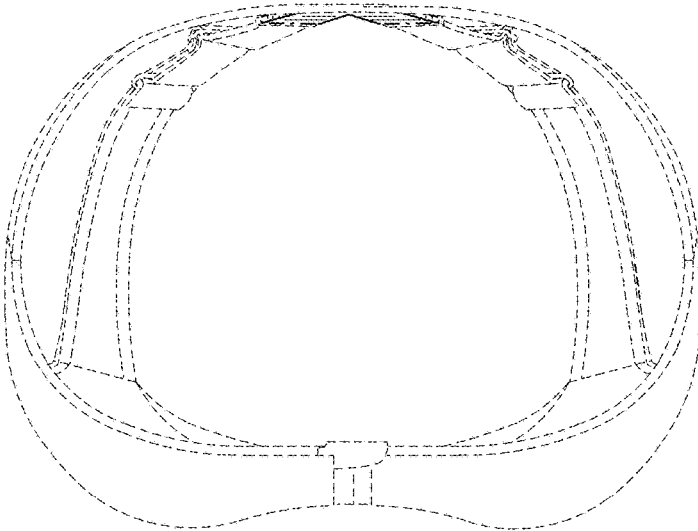

FIG. 8

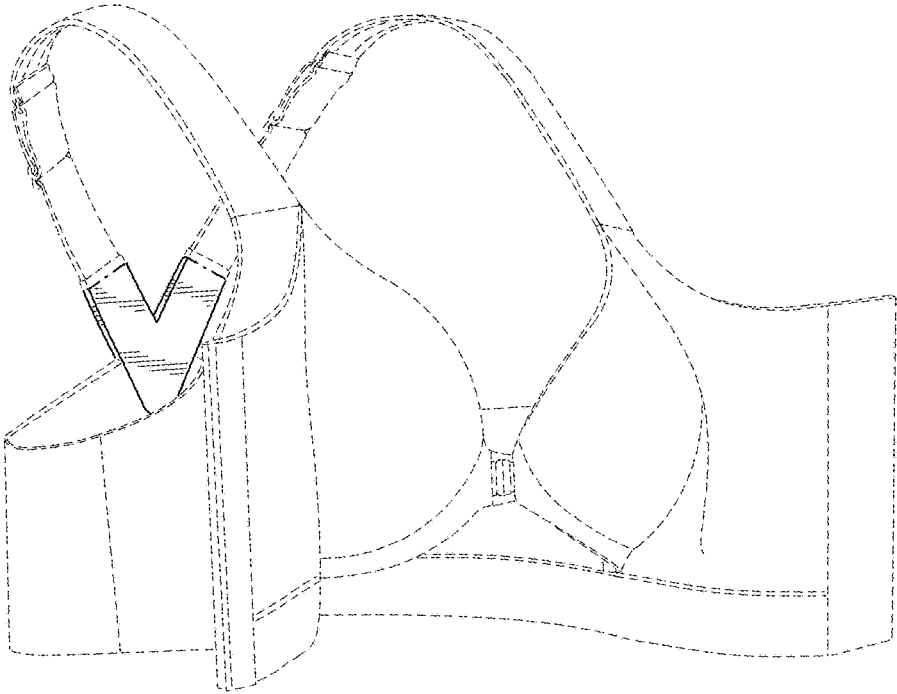

FIG. 9

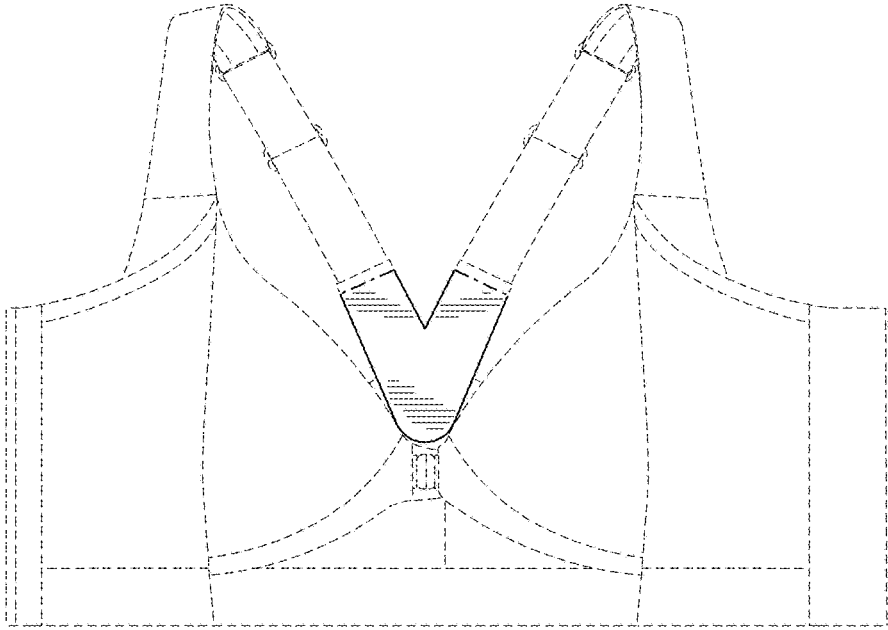

FIG. 10

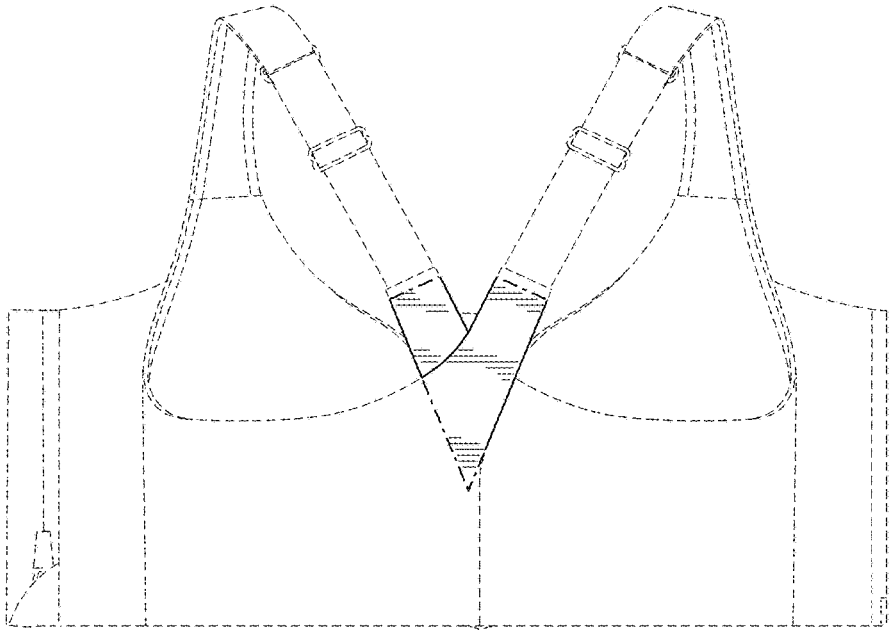

FIG. 11

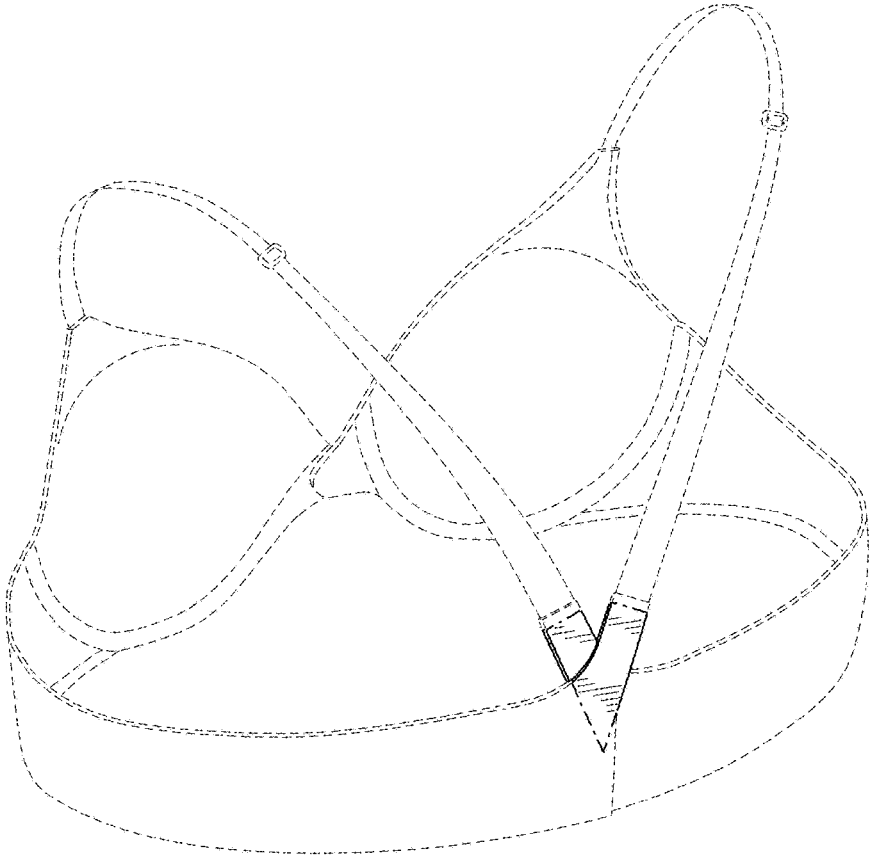

FIG. 12

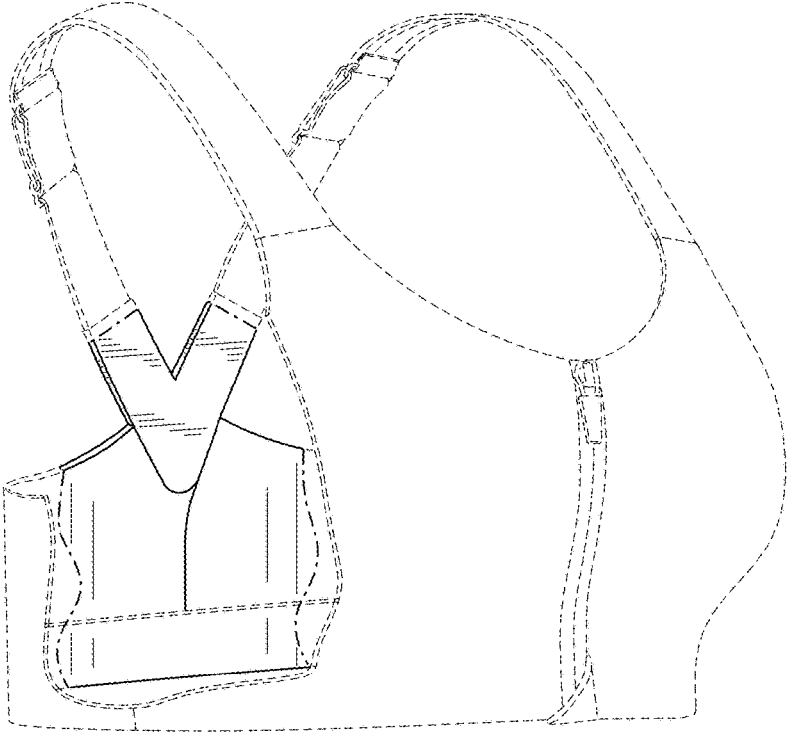

FIG. 13

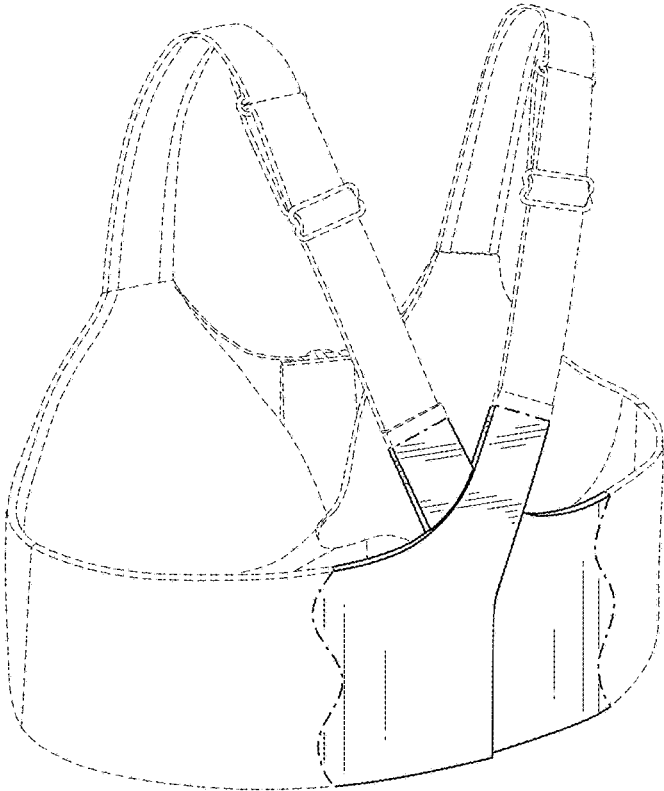

FIG. 14

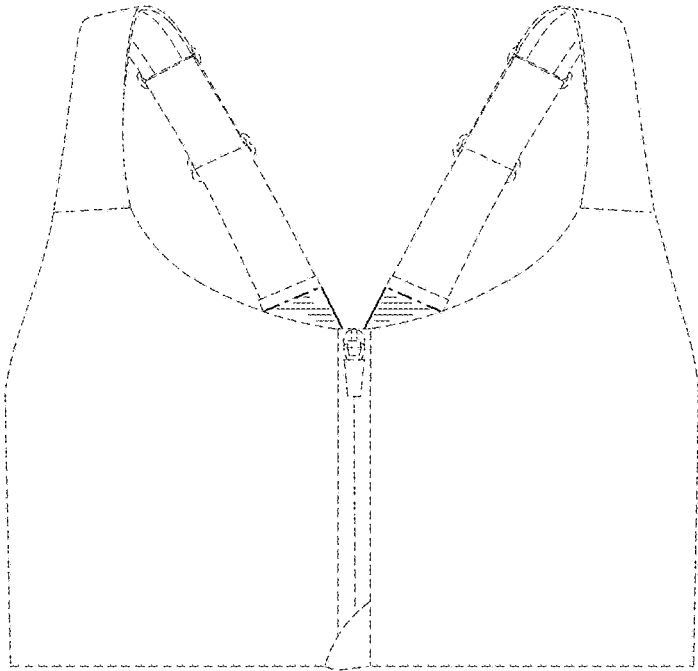

FIG. 15

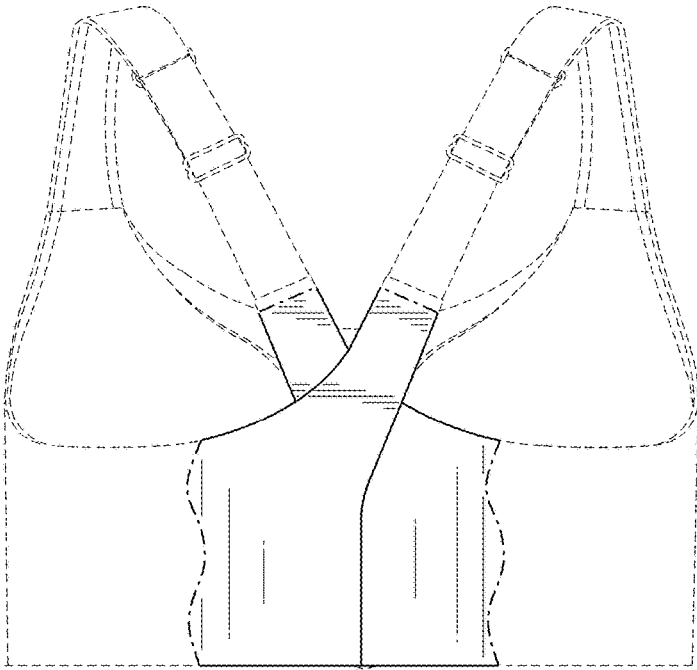

FIG. 16

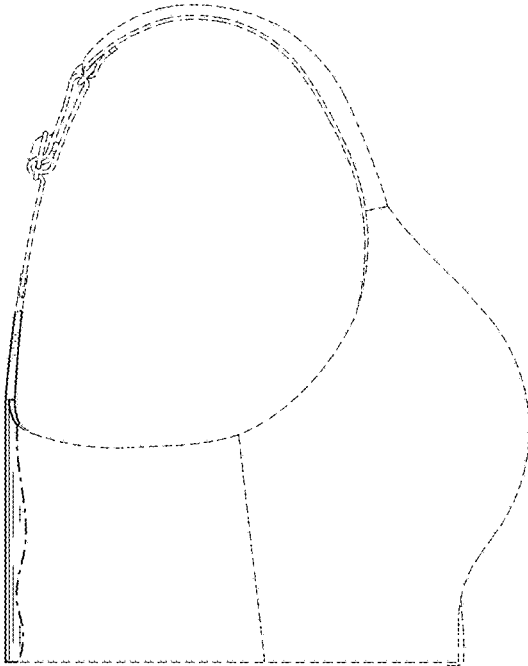

FIG. 17

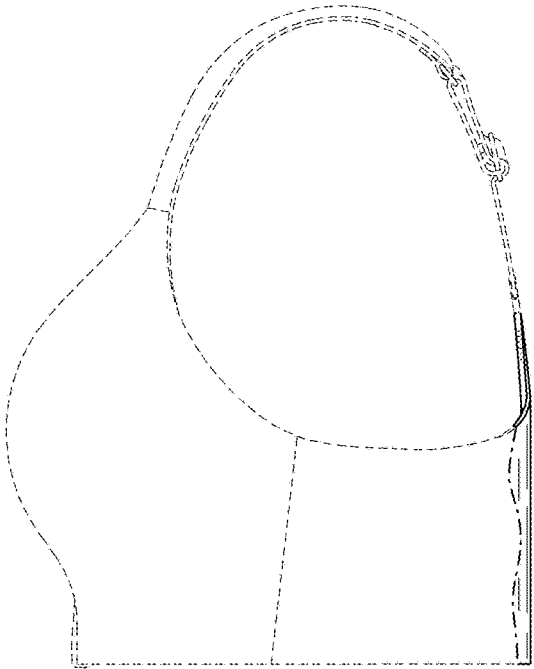

FIG. 18

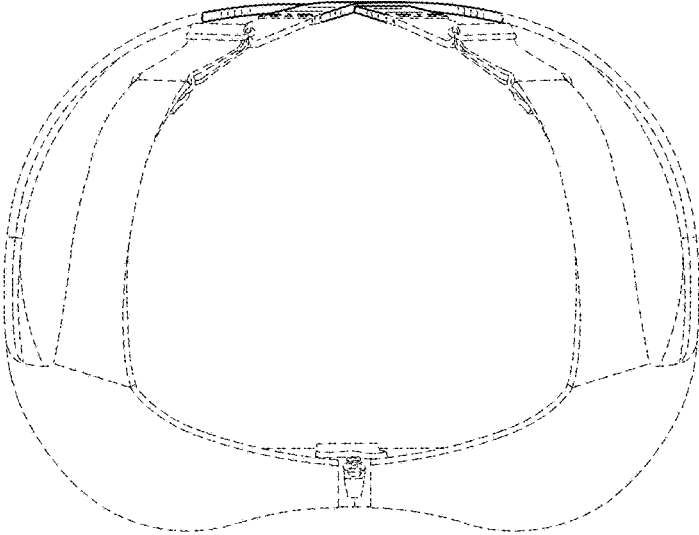

FIG. 19

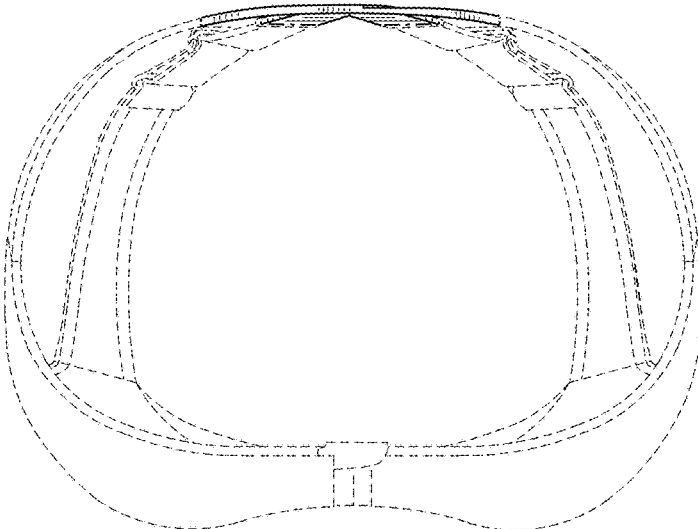

FIG. 20

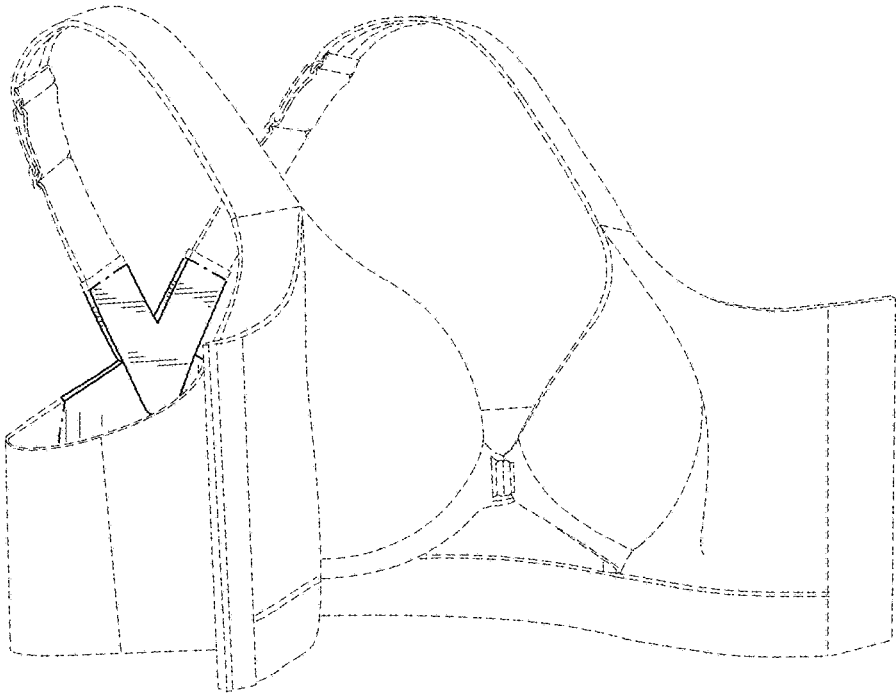

FIG. 21

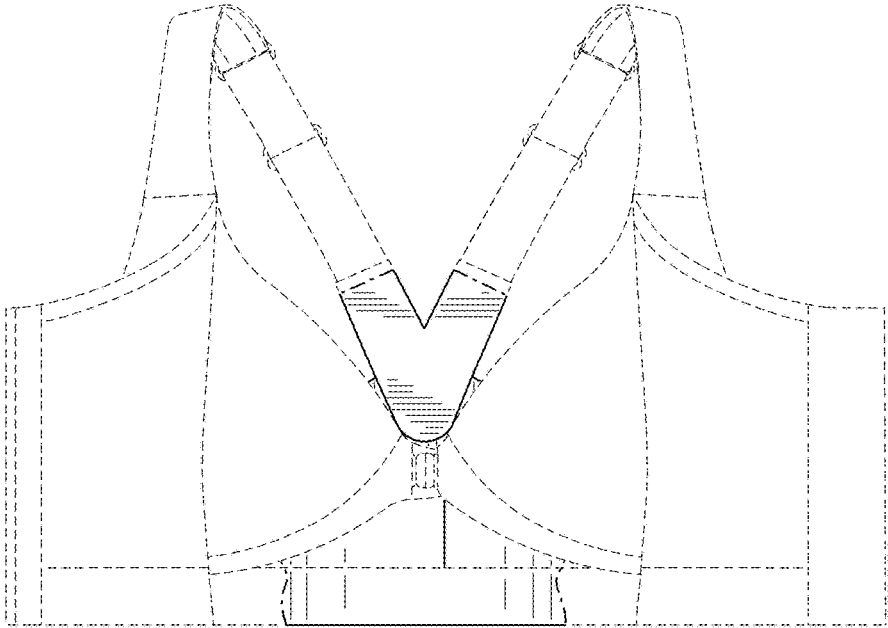

FIG. 22

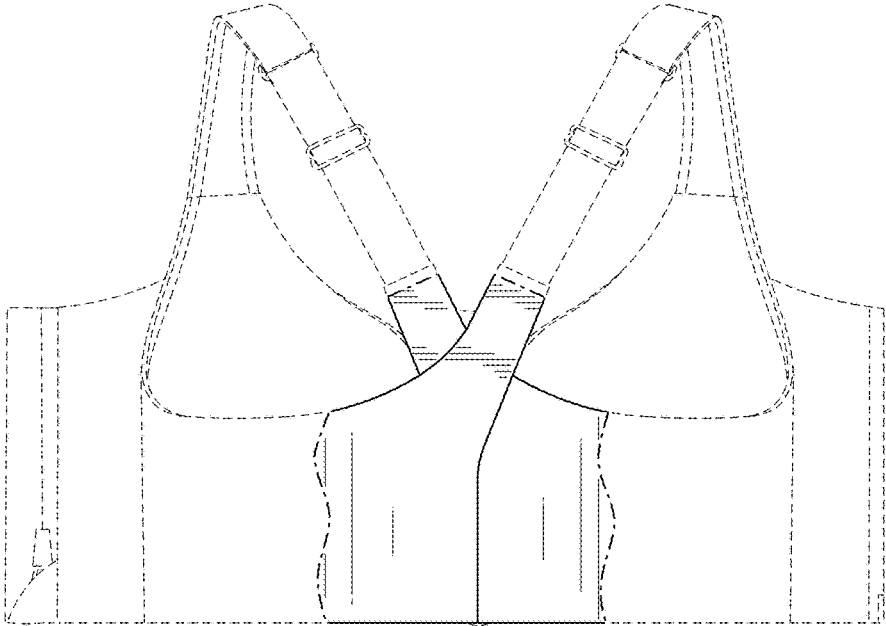

FIG. 23

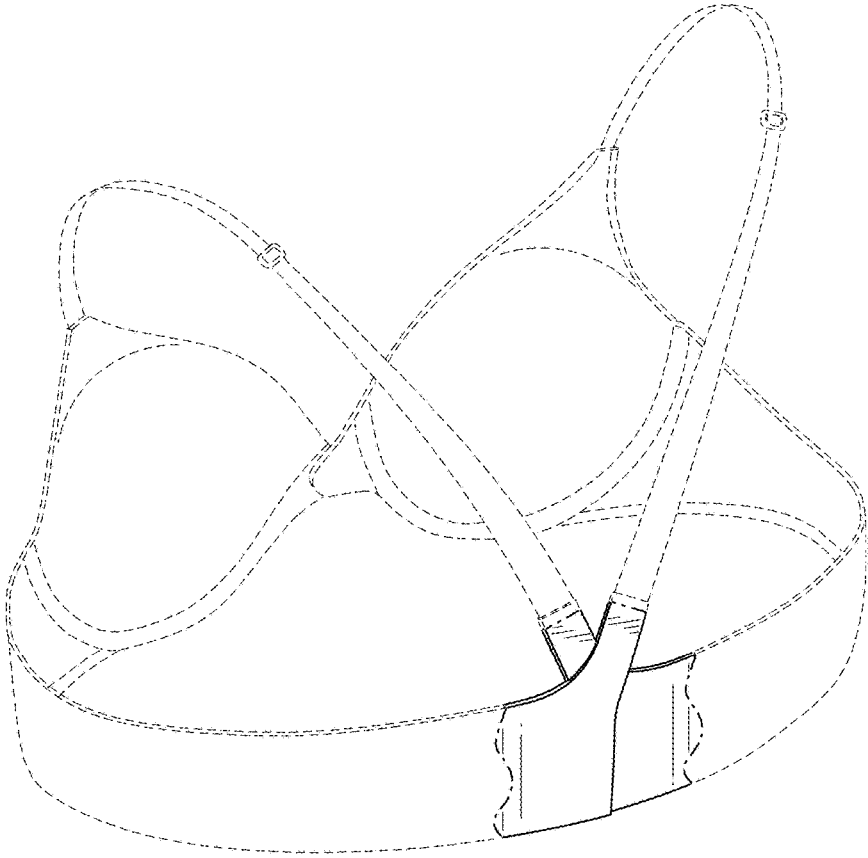

FIG. 24