



US00D842705S

(12) **United States Design Patent**
Erceg et al.

(10) **Patent No.:** **US D842,705 S**

(45) **Date of Patent:** **** Mar. 12, 2019**

(54) **BOTTLE**

(71) Applicant: **Victoria's Secret Stores Brand Management, Inc.**, Reynoldsburg, OH (US)

(72) Inventors: **Paige Erceg**, East Meadow, NY (US); **Karin Kleen**, Brooklyn, NY (US); **Sandra Monteparo**, Brooklyn, NY (US)

(73) Assignee: **Victoria's Secret Stores Brand Management, Inc.**, Reynoldsburg, OH (US)

(**) Term: **15 Years**

(21) Appl. No.: **29/608,660**

(22) Filed: **Jun. 23, 2017**

(51) **LOC (11) Cl.** **09-01**

(52) **U.S. Cl.**

USPC **D9/569**; D9/546; D9/574; D9/559

(58) **Field of Classification Search**

USPC D9/434, 435, 439, 445, 448, 516, 544, D9/559, 569, 563, 572, 573, 574, 682, D9/686, 692, 715, 719, 728; D3/205

CPC B65D 2501/0081; B65D 1/0223; B65D 51/18

See application file for complete search history.

(56) **References Cited**

U.S. PATENT DOCUMENTS

| | | | |
|--------------|---------|-------------------|--------|
| D382,809 S * | 8/1997 | Aldrich | D9/529 |
| D531,911 S * | 11/2006 | Lloyd | D9/546 |
| D545,208 S * | 6/2007 | Modjeski | D9/452 |
| D592,966 S * | 5/2009 | Nissen | D9/560 |
| D610,916 S * | 3/2010 | Yeung | D9/682 |
| D619,472 S * | 7/2010 | Papiernik | D9/454 |
| D639,667 S * | 6/2011 | Bogert | D9/439 |
| D659,548 S * | 5/2012 | de France | D9/694 |
| D678,073 S * | 3/2013 | Oge-Nichols | D9/542 |
| D684,865 S * | 6/2013 | Petronio | D9/520 |

| | | | |
|--------------|---------|----------------|--------|
| D740,660 S * | 10/2015 | Hughes | D9/435 |
| D753,500 S * | 4/2016 | Chertoff | D9/546 |
| D786,078 S * | 5/2017 | Futagami | D28/8 |

(Continued)

OTHER PUBLICATIONS

Gucci, Gucci Flora by Gucci Gorgeous Gardenia Perfume 0.16 oz EDT Mini for Women, website, last accessed Feb. 17, 2017, available at <http://www.sears.com/gucci-flora-by-gucci-gorgeous-gardenia-perfume-0.16/p-SPM9858771820?sid=IDx20110310x00001i&gclid=Cj0KEQIA25rFBRC8rfyX1vjev7YBEiQAFib3b77abINZH Zj3hVxG1RT7QDOB9wJTcattR3Jdk39k28aAsqB8P8HAQ&gclsrc=aw.ds>.

(Continued)

Primary Examiner — Ian Simmons
Assistant Examiner — Keith Frank
(74) *Attorney, Agent, or Firm* — Andrus Intellectual Property Law, LLP

(57) **CLAIM**

The ornamental design for a bottle, as shown and described.

DESCRIPTION

FIG. 1 is a top perspective view of a bottle according to our new and ornamental design;
FIG. 2 is a front elevation view thereof, wherein the rear elevation view thereof is identical except for the orientation of the spray nozzle;
FIG. 3 is a left side elevation view thereof, wherein the right side elevation view thereof is a mirror image;
FIG. 4 is a top plan view thereof;
FIG. 5 is a bottom plan view thereof; and,
FIG. 6 is a bottom perspective view thereof.
The broken lines depict portions of the bottle that form no part of the claimed design. The middle region of the bottle is shown broken away to indicate that the precise height of the bottle is not claimed. The appearance of any portion of the bottle between the two break lines forms no part of the claim.

1 Claim, 5 Drawing Sheets

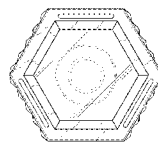
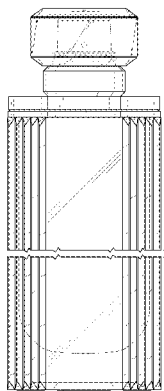

(56)

References Cited

U.S. PATENT DOCUMENTS

D798,156 S * 9/2017 Robson D18/56
D807,188 S * 1/2018 de Baschmakoff D9/553
D813,048 S * 3/2018 Hamel D9/556
D814,308 S * 4/2018 Aebi D9/560

OTHER PUBLICATIONS

Jimmy Choo, Illicit Eau de Parfum, 3.3 oz, website, last accessed Feb. 24, 2017, available at <http://shop.nordstrom.com/s/jimmy-choo-illicit-eau-de-parfum/4134767?origin=keywordsearch-personalizedsort>.

* cited by examiner

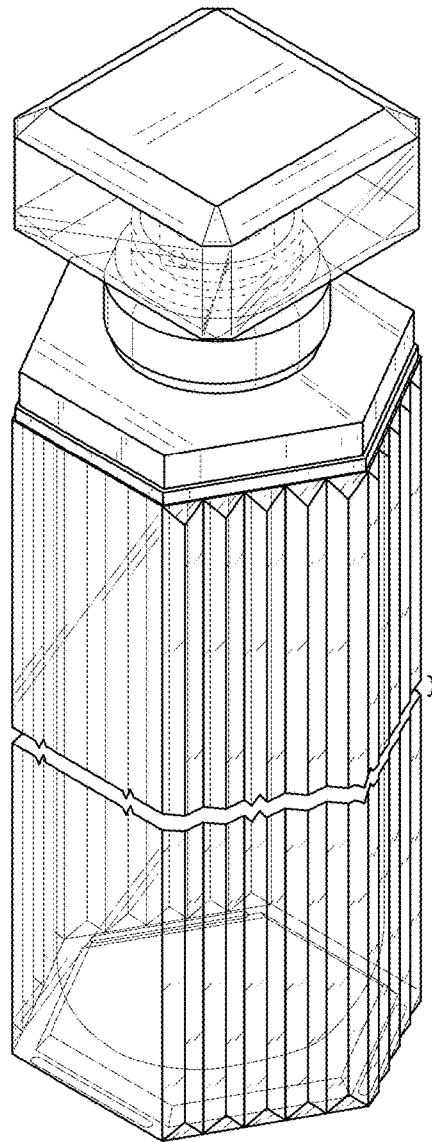

FIG. 1

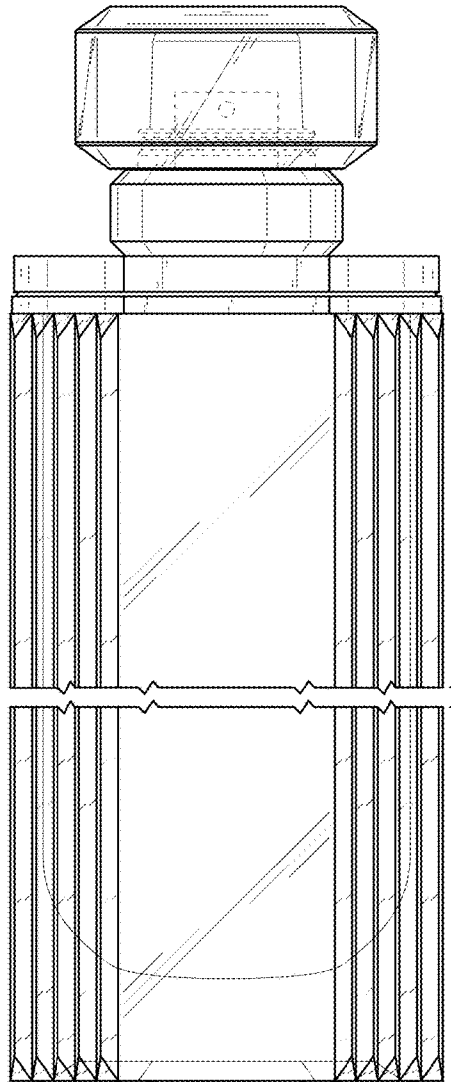

FIG. 2

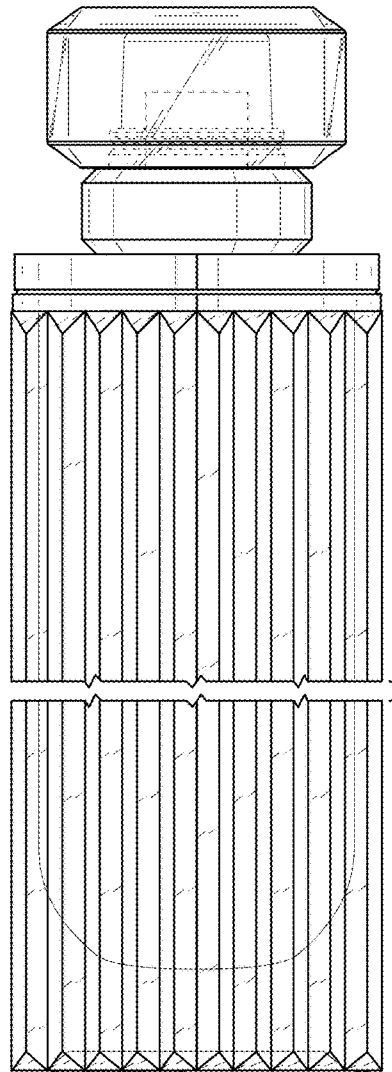

FIG. 3

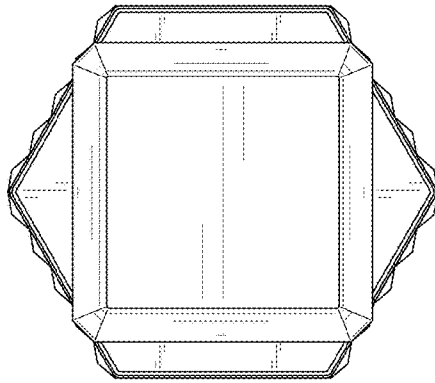

FIG. 4

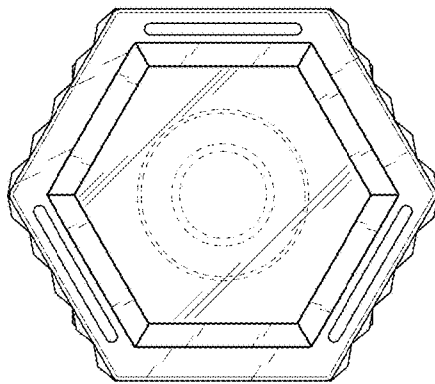

FIG. 5

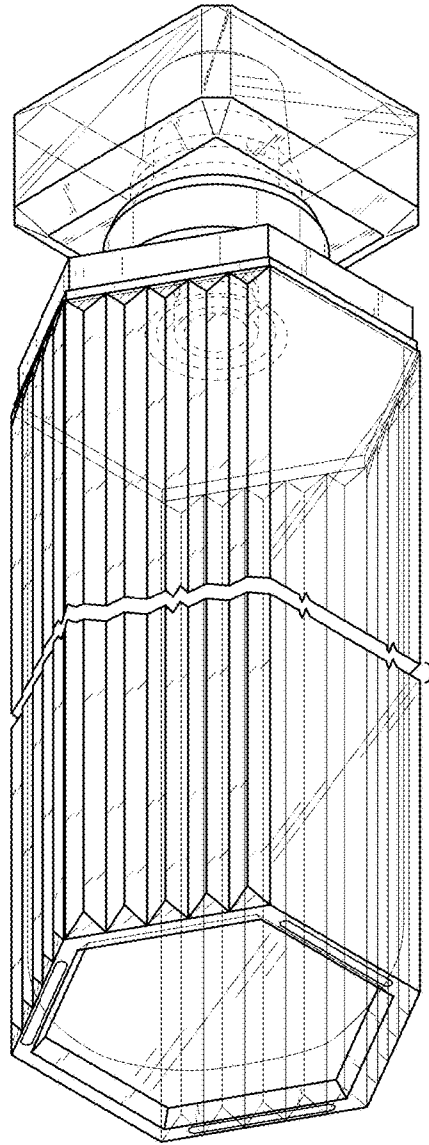

FIG. 6